

INSTRUCTION SHEET

MICRO/I™

HG2J-7U Series



Confirm that the delivered product is what you have ordered. Read this instruction sheet to make sure of correct operation. Make sure that the instruction sheet is kept by the end user.

Safety Precautions

- Be certain to read this instruction sheet carefully before performing installation, wiring, or maintenance work, or operating the HG2J-7U.
- This product has been manufactured with careful regard to quality. However, if you intend to use this product in applications where failure of this equipment may result in damage to property or injury, ensure that it used in conjunction with appropriate fail-safe backup equipment.
- Precautionary measure should be taken to avoid unauthorized access from the outside network to the HG2J-7U. Please note that the Company shall not be liable for any loss, damage or other expenses incurred directly or indirectly by unauthorized access, etc.
- In this operation instruction sheet, safety precautions are categorized depending on the severity as Warning or Caution:

WARNING

Warning notices are used to emphasize that improper operation may cause severe personal injury or death.

CAUTION

Caution notices are used where inattention might cause personal injury or damage to equipment.

WARNING

- The HG2J-7U is not designed for use in applications requiring a high degree of reliability and safety, such as applications for medical devices, nuclear power, railroads, aerospace, and automotive devices. The HG2J-7U should not be used for such applications.
- Turn off the power to the HG2J-7U before installation, removal, wiring, maintenance, and inspection of the HG2J-7U. Failure to turn power off may cause electrical shock or fire hazard.
- Special expertise is required to install, wire, configure, and operate the HG2J-7U. People without such expertise must not use the HG2J-7U.
- The HG2J-7U uses an LCD (liquid crystal display) as a display device. The liquid inside the LCD is harmful to the skin. If the LCD is broken and the liquid attaches to your skin or clothes, wash the liquid off using soap, and consult a doctor immediately.
- Emergency and interlocking circuits must be configured outside of the HG2J-7U.
- Do not use touch switches for an emergency circuit or an interlocking circuit.
- If the HG2J-7U fails, external equipment connected to the HG2J-7U will no longer be protected, and serious injury to operators and equipment damage may be caused.
- Stop using the HG2J-7U if it is accidentally dropped or exposed to significant shocks, check the HG2J-7U for damage, and confirm that its various functions work safely and correctly.
- For the HG2J-7U connect the FG wire to grounding resistance of 100 Ω or less. Otherwise there is a risk of electric shock or mistaken operation.
- Although the screen will not be visible if the backlight of the HG2J-7U burns out, the touch panel will remain functional.
- Incorrect touch panel operation will occur when operating the touch panel when the backlight appears to be turned off but is actually burnt out. Because such erroneous operation could result in damage, the touch panel should not be used after the backlight has burned out.

CAUTION

- Prevent the HG2J-7U from falling while moving or transporting, otherwise damage or malfunction of the HG2J-7U will result.
- Use the product within the environmental limits given in the catalog and manual. Use of the product in high-temperature or high-humidity environments, or in locations where it is exposed to condensation, corrosive gas or large shock loads can create the risk of electrocution and fire.
- The HG2J-7U is designed for use in pollution degree 2. Use the HG2J-7U in environments of pollution degree 2. (based on the IEC60664-1 rating)
- Install the HG2J-7U according to the instructions in the User's Manual. Improper installation will result in falling, failure, electrical shock, fire hazard, or malfunction of the HG2J-7U.
- Prevent metal fragments or wire chips from dropping inside the HG2J-7U housing. Ingress of such fragments and chips may cause fire hazard, damage, and malfunction.
- Use a power supply of the rated value. Using a wrong power supply may cause fire hazard.
- The HG2J-7U uses "PS2 of EN61131" as DC power supply. (based on the IEC / EN61131 rating)
- Use wire of a proper size to meet the voltage and current requirements.
- When exporting the HG2J-7U to Europe, use an EN60127 (IEC60127) approved fuse on the power line outside the HG2J-7U.
- When exporting the HG2J-7U to Europe, use an EU-approved circuit protector.
- Make sure of safety before starting and stopping the HG2J-7U. Incorrect operation of the HG2J-7U may cause mechanical damage or accidents.
- Use the HG2J-7U in a local area network if you download, upload or monitor the project data via the Ethernet port.
- The touch panel of the HG2J-7U is made of glass, and will break if exposed to excessive shock. Take due care when handling it.
- The protective film attached to the display of the programmable display is to protect the product from scratches during transportation. Please remove the protective film before use. If the display is used with protective film, the film may become cloudy and stick to the display depending on the usage environment and may become unremovable.
- Do not push hard or scratch the touch panel and protection sheet with a hard object such as a tool, because they are damaged easily.
- For applications which require clock accuracy, adjust the clock periodically.
- Do not install the HG2J-7U in areas subjected to strong ultraviolet rays, since ultraviolet rays may impair the quality of the LCD.
- Do not attempt to disassemble, repair or modify the HG2J-7U. This can create the risk of fire or electrocution.
- When disposing of the HG2J-7U, do so as an industrial waste.
- Do not switch off the power or pull out the USB flash drive while it is being accessed, as this may result in destruction of the stored data. If the data on the USB flash drive is corrupted, format the USB flash drive.

UL 121201 / CSA C22.2 No.213

- The HG2J-7U is for indoor use only.
- Open type or panel mounted when installed in a Listed Type 4X "Indoor Use Only", Type 13 enclosure.
- The use of an SELV source.
- When wiring the HG2J-7U at the field, use copper conductors only.

Test item particulars	
Type of item	Open Type/enclosed type when panel mounted in appropriate end enclosure
Description of equipment function	Control
Connection to mains supply	N/A connected to SELV source
Overvoltage Category	None
Pollution Degree	2
Means of Protection	Class III
Environmental Conditions	Extended:
Temperature:	-20 to +60°C, see RATINGS section for detail.
Humidity:	10 to 90%RH (no condensation)
For use in wet locations	NO
Equipment mobility	Panel mounted
Operating Conditions	Continuous

- The HG2J-7U is suitable for use in Class I, Division 2, Groups A, B, C, D or Non-Hazardous locations only.
- RATINGS:**
Input: 12/24 Vde, 13W, SELV, LIM
Maximum Surrounding Air: -20 to +60°C
Enclosure Type 4X Indoor Use only, Type 13
Temperature Code: T4A
- Equipment to be installed in an environmentally suitable enclosure that requires the use of a tool to access.

- L'appareil HG2J-7U est conçu pour être utilisé uniquement dans des emplacements de classe I, division 2, groupes A, B, C, Dou non dangereux.
- Caractéristiques:Entree: 12/24 Vde, 13W, Tres basse tension de securite (SELV), LIMITES Air ambiant maximal: -20 a +60°C
Boitiers de type 4X pour une utilisation interieure, de type 13.
- Code de temperature: T4A
- L'appareil HG2J-7U doit être installé dans un boîtier adapté à l'environnement et uniquement accessible à l'aide d'outils.

1 Packing Content

Before installing the HG2J-7U, make sure that the specifications of the product conform to your requirements, and that no parts are missing or damaged due to accidents during transportation.

- Unit (1)
- Mounting Clips (4)
- Host Communication Plug (1) (Attached to the HG2J-7U)

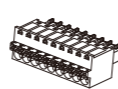
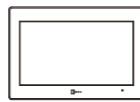

2 Type No.

HG2J-7UT22TF-B

LCD Size: 7.0 inch wide
Bezel color: Black

3 Part Names

HG2J-7U (7.0 inch)

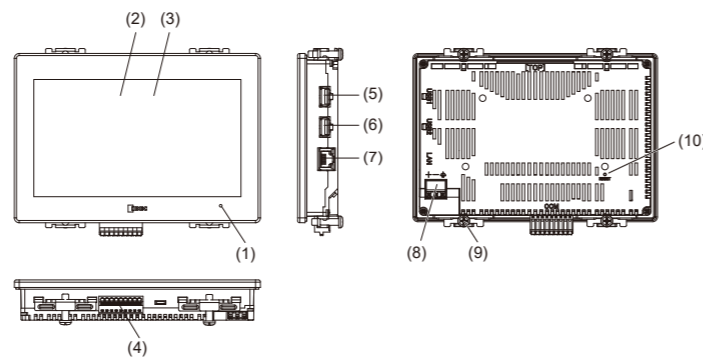

No.	Name	Description
(1)	POWER LED	Green (lit): Normal Operation Green (flash): Operating system is booting (Normal Operation) Orange (lit): Operating system is booting (Boot mode) Orange (flash): Preparing to boot the operating system, running in boot mode Red (lit): Main unit is damaged Not lit: Power is OFF
(2)	Display	-
(3)	Touch Panel	-
(4)	Serial Interface (COM)	RS232C, RS422/485 Connector: Terminal Block 9-pin (Push-in type) Maximum Cable Length: 15m (RS232C), 1,200m(RS422/485)
(5)	USB Interface (USB1)	USB2.0 (Host) Connector: Type A Output current: 5V/500mA
(6)	USB Interface (USB2)	USB2.0 (Host) Connector: Type A Output current: 5V/500mA
(7)	Ethernet Interface (LAN)	IEEE802.3u 10BASE-T/100BASE-TX Connector: RJ-45 (With Auto MDI/MDI-X Function) Maximum Cable Length: 100m
(8)	Power Supply Terminal	Connector: Terminal Block 3-pin (Push-in type)
(9)	Mounting Clip Position	4 places
(10)	RESET Switch	-

4 External Interfaces

CAUTION

- Make sure to turn off the power to the HG2J-7U before wiring each interface.
- The serial interface (COM) can be used as the RS232C and RS422/485 interfaces at same time.
- Use the SELV (Safety Extra-Low Voltage) circuit to connect the Serial, USB and Ethernet interfaces.

4.1 Serial Interface (COM)

- Use applicable cables for wiring and recommended ferrules (made by IDEC, Weidmüller or Phoenix Contact) as follows.

Interface Specification	RS232C, RS422/485
Connector	Detachable Terminal Block 9-pin
Applicable Cable	AWG 16 to AWG 28
Conductor Type	Solid or stranded wire
Wire Strip Length*1	8 to 9mm
Recommended ferrule	ST3L-H025-12WJ, S3TL-H034-12WT, S3TL-H05-14WA, S3TL-H075-14WWW (IDEC) H0,25/12 HBL, H0,34/12 TK, H0,5/14 OR, H0,75/14 W (Weidmüller) AI 0,25-8YE, AI 0,34-8TQ, AI 0,5-8WH, AI 0,75-8GY (Phoenix Contact)

*1 Strip the sheath of the wire 8 to 9mm from the end.

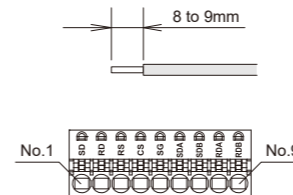

No.	Name	I/O	Function	Communication type
1	SD	OUT	Send Data	RS232C
2	RD	IN	Receive Data	
3	RS	OUT	Request to Send	
4	CS	IN	Clear to Send	RS422/485
5	SG	-	Signal Ground	
6	SDA	OUT	Send Data (+)	
7	SDB	OUT	Send Data (-)	
8	RDA	IN	Receive Data (+)	
9	RDB	IN	Receive Data (-)	

HG2J-7U is not equipped with terminating resistor. Insert a terminating resistor of an appropriate value (about 100 to 120 Ohm, 1/2W minimum) between terminal number 8 (RDA) and terminal number 9 (RDB), if necessary.

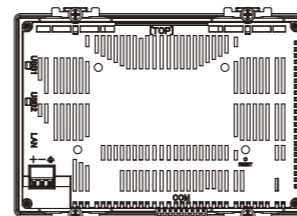

Terminal Number 8 (RDA) Terminal Number 9 (RDB)

For inserting and removing wires, see the "8. Wiring" section.

5 Specifications

Applicable Standards

Safety Standard	UL61010-1, UL61010-2-201, UL121201 CSA C22.2 No.61010-1-12 (c-UL) CSA C22.2 No.61010-2-201 (c-UL) CSA C22.2 No.213 (c-UL)
EMC Standard	IEC/EN 61131-2

Environmental Specifications

Operating Ambient Temperature	-20 to +60°C *1
Operating Relative Humidity	10 to 90%RH (no condensation)
Storage Ambient Temperature	-20 to +70°C
Storage Relative Humidity	10 to 90%RH (no condensation)
Altitude (Operation)	0 to 2,000m
Pollution Degree	2
Corrosion Immunity	Free from corrosive gases

Electrical Specifications

Rated Operating Voltage	12V DC / 24V DC
Power Consumption	13W maximum
When not using USB1 and USB2	5W maximum
	When the Backlight is off
Power Voltage Range	10.2 to 28.8V DC
Allowable Momentary Power Interruption	10ms maximum (Power supply: 20.4 to 28.8V DC) 1ms maximum (Power supply: 10.2 to 20.4V DC)
Inrush Current	40A maximum
Dielectric Strength	AC500V, 10mA, 1minute (between power and earth terminals)

Construction Specifications

Vibration Resistance	5 to 8.4Hz amplitude 3.5mm 8.4 to 150Hz acceleration 9.8m/s² 10 times on each of three mutually perpendicular axes (IEC61131-2)
Shock Resistance	147m/s² 11ms (3 shocks on each of three mutually perpendicular axes) (IEC61131-2)

Performance Specifications

Display	LCD Type *2	TFT color LCD (TN Type)
	Display Colors	65,536 Colors
	Effective Display Area	154.08(W) × 85.92(H) [mm]
	Display Resolution	800(W) × 480(H) dots
	Dot pitch	0.1926(W) × 0.179(H) [mm]
TouchPanel	View angle	Left/Right/Top: 80°, Bottom: 60°
	Brightness of LCD only	Typ.500 [cd/m²]
	Brightness Adjustment	48 levels
Backlight	Backlight	LED
	Backlight Life *3	Approx. 50,000 hours (The time until brightness becomes 50% of the initial value.)
	Switch Type	Projected Capacitive
Multiple Operations	Possible (2-point touch)	
User Memory	Approx. 24MB	
Backup of the real-time clock at 25 °C	Typ. 20 days	
Backup Data	Calendar, Log Data, Keep Internal relay/resister	
Buzzer output	Single tone (tone length is adjustable)	
Degree of Protection *4	When panel thickness is 1 to 5 mm: IP65F (IEC60529) When panel thickness is 1.6 to 5 mm: IP66F, IP67F (IEC60529), TYPE 4X (indoor use only), TYPE 13	
Weight (Approx.)	500g	

*1 For details about the output current limitation of the USB interface due to the operating ambient temperature, refer to "7.3 HG2J-7U Orientation" section.

*2 Please be aware that small black and bright dots might show up on LCD Screen: it is not a failure or malfunction.

*3 The life of the LCD itself at an ambient temperature of 25°C. This is not a guaranteed value.

The actual life depends on the environment and conditions of use.

*4 It is a protection structure for the operating surface of HMI, which is attached to a panel. Although protection structure suffices every test conditions, it does not guarantee to operate under all of the environmental condition.

As for IP66F/IP67F oilproof structure, it suffices oilproof test conditions. Conditions are listed in the document that comes with Japanese Industrial Standard JIS C 0920.

Protection structure do not guarantee usage under long exposure to oil or usage of oil that is not prescribed in the document. Please test/check beforehand to avoid trouble.

IP ratings are not applicable to UL certification.

EMC Specifications

Radiated Emission	Class A: 10m 40dBµV/m quasi-peak (30M to 230MHz) 47dBµV/m quasi-peak (230M to 1GHz) Class A: 3m 76dBµV/m (Peak), 56dBµV/m (AVG) (1G to 3GHz) 80dBµV/m (Peak), 60dBµV/m (AVG) (3G to 6GHz)
Electrostatic Discharge	Contact: ±6kV Air: ±8kV
Electromagnetic Field	10V/m (80~1000 MHz) 3V/m (1.4~2.0GHz) 3V/m (2.0~2.7GHz) 3V/m (2.7~6.0GHz) 80% AM (1kHz)
Fast Transient Burst	Power: ±2kV Communication cable: ±1kV
Surge Immunity	±500V (between +24V and 0V) ±500V (between -24V and FE, 0V and FE)
Conducted Radio Frequency Immunity	3V (Power, Communication cable) (150k to 80MHz) 80% AM (1kHz)

6 Dimensions

HG2J-7U (7.0 inch)

All dimensions in mm.

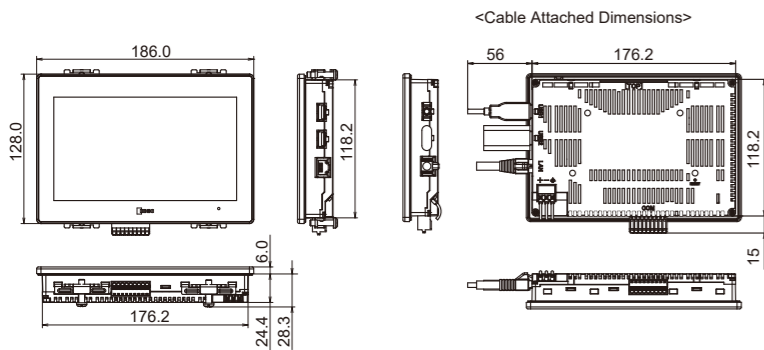

Depending on the type of connection cable used the dimensions shown above will change. The dimensions given here are representative values and are intended for reference only.

About the printed contents of the main unit

"Mark A" indicates that you can refer to this instruction sheet by using the QR code. For details, "8. Wiring" section.

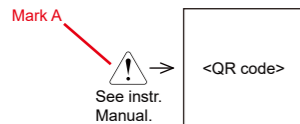

7 Installation

7.1 Operating Environment

For designed performance and safety of the HG2J-7U, do not install the HG2J-7U in the following environments:





- Where dust, briny air, or iron particles exist.
- Where oil or chemical splashes for a long time.
- Where space is filled with oil mist.
- Where direct sunlight falls on the HG2J-7U.
- Where strong ultraviolet rays fall on the HG2J-7U.
- Where corrosive or combustible gasses exist.
- Where shocks or vibrations are transmitted.
- Where condensation occurs due to rapid temperature change.
- Where high-voltage or arc-generating equipment (electromagnetic contactors or circuit protectors) exists in the vicinity.

7.2 Ambient Temperature

- Allow sufficient space for ventilation, and install the equipment away from heat sources.
- Allow at least 100mm between the HG2J-7U and walls or other equipment.
- Do not install the HG2J-7U where the ambient temperature exceeds the rated operating ambient temperature range. When mounting the HG2J-7U in such locations, provide a forced air-cooling fan or air-conditioner to keep the ambient temperature within the rated temperature range.

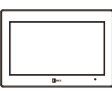
7.3 HG2J-7U Orientation

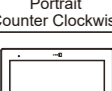
The HG2J-7U is designed to install on a vertical landscape. The operating ambient temperature and the output current of the USB interface (total of USB1 and USB2) are limited as shown in the table below.

Orientation	Operating Temperature: Output current
 Landscape	-20 to +45°C: 1,000mA +45 to +55°C: 500mA +55 to +60°C: 150mA
 Portrait (Clockwise)	-20 to +40°C: 1,000mA +40 to +55°C: 500mA +55 to +60°C: 150mA
 Portrait (Counter Clockwise)	-20 to +40°C: 1,000mA +40 to +55°C: 500mA +55 to +60°C: 150mA
 Landscape (Rotate 180°)	-20 to +55°C: 500mA +55 to +60°C: 150mA
 Horizontal	-20 to +40°C: 1,000mA +40 to +55°C: 500mA +55 to +60°C: 150mA

<Note>

- When installing the HG2J-7U in a diagonal, the limitations are same as a horizontal.
- Confirm the visibility of the display in a final installation.

7.4 HG2J-7U Installation

- Make a panel cut-out on the panel with the dimensions shown below.

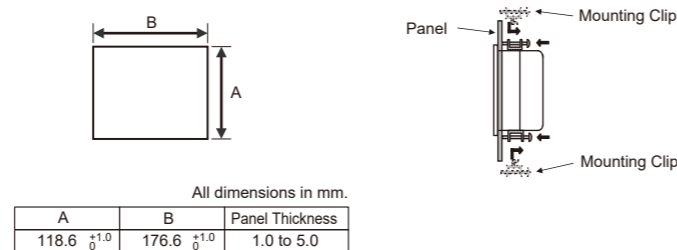

- Place the HG2J-7U in a panel cut-out and fasten with the attached mounting clips at the four places to a specified torque of 0,5 to 0,6N-m uniformly.

CAUTION

- Mount the HG2J-7U on a rigid panel.
- Do not tighten with excessive force, otherwise the HG2J-7U may warp on the display, or impair the waterproof characteristics.
- If the mounting clips are tightened obliquely to the panel, the HG2J-7U may fall off the panel.
- When installing the HG2J-7U into a panel cut-out, make sure that the gasket is not twisted. Especially when re-installing, take special care because any twists in the gasket will impair the waterproof characteristics.

8 Wiring

CAUTION

- Turn off the power supply before wiring.
- Make the wiring as short as possible and run all wires as far away as possible from high-voltage and large-current cables. Follow all the procedures and precautions when wiring the HG2J-7U.
- Separate the HG2J-7U power supply wiring from the power lines of I/O devices and motor equipment.
- Ground the functional earth terminal to make sure of correct operation.
- Use the SELV (Safety Extra-Low Voltage) circuit and LIM (Limited Energy) circuit for power supply.
- Use wire copper conductor only.

8.1 Power Supply Terminal

- Pin assignment is shown in the following table.



+	Power supply 12V DC / 24V DC
-	Power supply 0V
⏏	Functional Earth (FE)

- Use applicable cables for wiring and recommended ferrules (made by IDEC, Weidmüller or Phoenix Contact) as follows.

Applicable Cable	AWG 14 to AWG 28
Conductor type	Solid or stranded wire
Wire Strip Length*1	7 to 9mm
Recommended ferrule	ST3L-H025-12WJ, S3TL-H034-12WT, S3TL-H05-14WA, S3TL-H075-14WW (IDEC) H0,25/12 HBL, H0,34/12 TK, H0,5/14 OR, H0,75/14 W (Weidmüller) AI 0,25-8YE, AI 0,34-8TQ, AI 0,5-8WH, AI 0,75-8GY (Phoenix Contact)

*1 Strip the sheath of the wire 7 to 9mm from the end.

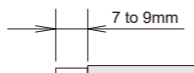

8.2 Precautions when inserting and removing wires

- When connecting a stranded wire, insert the wire fully in the wiring port. Wire is connected when the pusher is released.
- When connecting a wire with ferrules, connect to the terminal block so that the ferrule longer direction faces sideways. (Refer to the below diagram.)

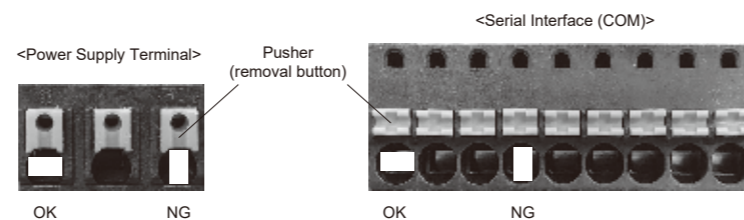

- When disconnecting a wire, use a flat blade screwdriver or similar tool and press the pusher (removal button) with approximately 20 N of force while pulling the wire straight out.
- Be careful not to damage the push-in terminal. Do not apply 40 N or more of force when pressing the pusher. Do not pull out the cable without pressing the pusher.

8.3 Recommended Tools

The following recommended tools can be used.

Tool Name	Normal type	Model Number (Order Number)	Manufacture Name
Flat blade screwdriver	Normal type	SDS 0.4×2.5×75 (2749320000)	Weidmüller
	With insulated cover	S3TL-D04-25-75 SDIS 0.4×2.5×75 (2749790000)	Weidmüller
Crimping tool		S3TL-CR06D	IDEC
		PZ6/5 (90011460000)	Weidmüller
Stripping tool		S3TL-ST06	IDEC
		STRIPAX (9005000000)	Weidmüller

8.4 Cautions for using the HG2J-7U connected to a personal computer

When connecting the HG2J-7U to a personal computer via the USB interfaces, the HG2J-7U or the personal computer may break down depending on the conditions of the personal computer.

Make sure of the following cautions, in order to prevent an accident.

- If the personal computer has a 3-pin power plug or power plug with a ground lead type, make sure to use a plug socket including a ground input electrode or ground the earth lead, respectively.
- If the personal computer has a 2-pin power plug without ground lead, follow the procedure below when connect the HG2J-7U to the personal computer.
 - (1) Pull out the power plug of the personal computer from the AC outlet.
 - (2) Connect the HG2J-7U to the personal computer.
 - (3) Insert the power plug of the personal computer into the AC outlet.

9 Maintenance and Inspection

Maintain and inspect the HG2J-7U periodically to ensure the best performance. Do not disassemble, repair, or modify the HG2J-7U during inspection.

Display	Wipe any stain of the display using a soft cloth slightly dampened with neutral detergent or alcoholic solvent. Do not use solvents such as thinner, ammonia, strong acid, and strong alkaline.
Terminals, Connectors	Check the terminals and connectors to make sure of no incomplete insertion, or disconnected lines.
Mounting Clips	Make sure that all mounting clips and screws are tightened sufficiently. If the mounting clips are loose, tighten the screw to the recommended tightening torque.
Backlight	The HG2J-7U's backlight cannot be replaced by the customer. When the backlight needs to be replaced, Contact IDEC.

IDEC CORPORATION

<http://www.idec.com>

Manufacturer: IDEC CORPORATION, 2-6-64 Nishimiyahara, Yodogawa-Ku, Osaka 532-0004, Japan
 EU Authorized Representative: APEM SAS
 55, Avenue Edouard Herriot BP1, 82303 Caussade Cedex, France
 UK Authorized Representative: APEM COMPONENTS LIMITED
 Drakes Drive, Long Crendon, Buckinghamshire, HP18 9BA, UK

2021.10